

Part number:

HYDROMA

HYDRAULICKÉ SYSTÉMY

**HIDROMA
SYSTEMS**

UKŁADY HYDRAULICZNE

HYDROMA

ГИДРАВЛИЧЕСКИЕ СИСТЕМЫ

6/2 ways/positions flow diverters L710... (VS120A-VS125A-VS129A)



Size 4

Series 00

Maximum operating pressure 310 bar (4500 psi)

Maximum flow 25 l/min (6.6 gpm)

Ports G 1/4 - SAE4 - JIS B 1/4

General specifications

- 6 way 2 position valve.
- Directional spool valve with direct solenoid control.
- Hydraulic / pneumatic pilot available as option.
- Control spool operated by solenoid, with easily removable coil fastened by a ring nut.
- Wet pin tube for DC coil, with push rod for mechanical override in case of voltage shortage.
- Unrestricted 360° orientation of DC coil.
- Control spool held in normal position by return spring.
- Optional manual override (push-button or screw type).
- Connectors available: DIN 43650 – ISO 4400, AMP Junior, DT04-2P (Deutsch), Free leads.

Contents

Ordering details	2
Symbols	2
Functional description	3
Technical data	3
Characteristic curve	5
External dimensions and fittings	6
Electric connection	8

Ordering details

01	02	03	04	05	06	07	08
L	7	10					0

Family	
01	Compact directional valve
	L

Type	
02	Flow diverters
	7

Ports		
03	G 1/4 DIN 3852	2
	7/16-20 UNF(SAE4)	A
	JIS B G 1/4	J

Control type		
04	Solenoid (coil D36) without manual override	A0
	Solenoid (coil D36) with push-button type manual override	AP
	Solenoid (coil D36) with screw type manual override	AF
	Hydraulic / pneumatic control ¹⁾	P1

Spool variants		
05	6 way / 2 position P1 side	6_
	6 way / 2 position P2 side	7_

Drain type		6A	7A	6C	7C	6E	7E	
06	Internal drain	●	●	●	●	-	-	I
	External drain	●	●	●	●	●	●	E

Voltage supply		31	07	04	03	01	00	
07	Without coil	-	-	-	-	-	●	00
	12 V DC	●	●	●	●	●	-	OB
	24 V DC	●	●	●	●	●	-	OC
	48 V DC	-	●	●	●	●	-	OD
	96 V DC	-	-	-	-	●	-	OU
	205 V DC	-	-	-	-	●	-	AH

Electric connections		
08	Without coils	00
	With coils, without mating connector DIN EN 175301-803 ²⁾	01
	With coils, with bi-directional diode, without mating connector vertical Amp-Junior	03
	With coils, with bi-directional diode, without mating connector horizontal Amp-Junior	04
	With coils, with bi-directional diode, without mating connector DT04-2P	07
	With coils and bipolar sheathed lead 300mm (11,8 in) long	31

● = Available - = Not available

Symbols

Drain type I

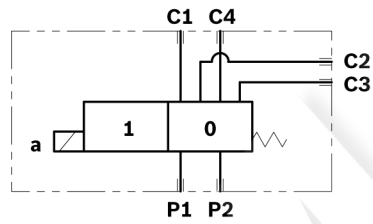

Drain type E

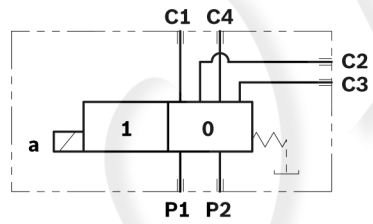

Spool variants

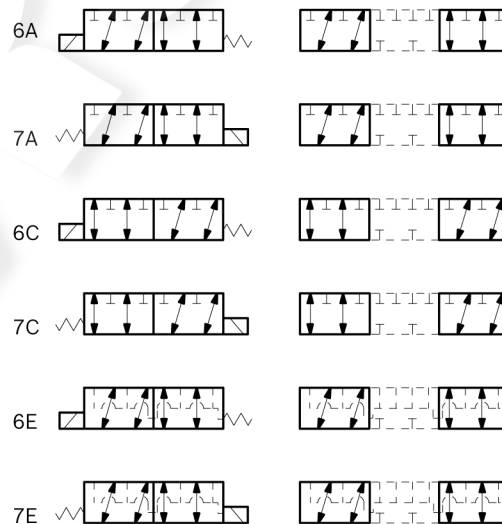

- Minimum pressure 4 bar (58psi) with external drain (E), maximum pressure 200 bar (2901psi). With internal drain (I), at the minimum pressure (4 bar - 58psi), add the working pressure with ratio of 6,5:1. Example: With working pressure 100 bar (1450psi), minimum pilot pressure is 19.38 bar (281psi) $((100:6,5) + 4$ bar (58psi)).
- For connectors ordering code see data sheet RE 18325-90.

Functional description

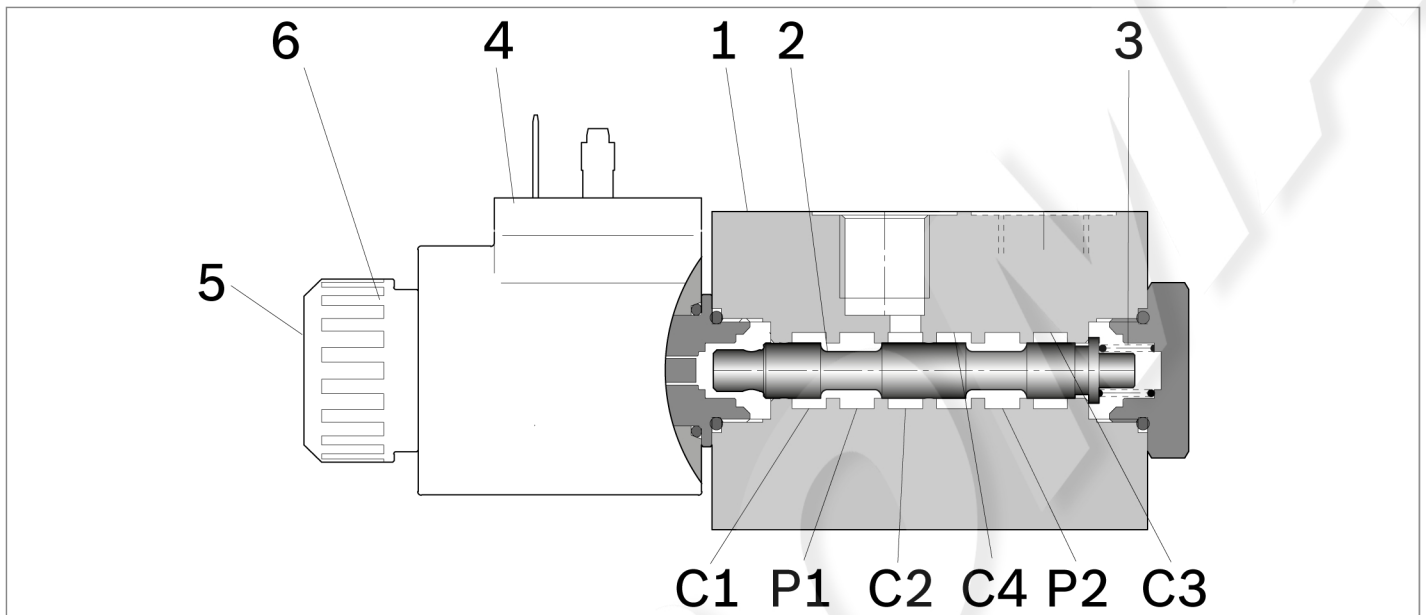

A valve basically consists of a housing (1), a control spool (2), a return spring (3) and a solenoid (4). It is designed to connect two inlet lines P1 – P2 (normally a set of hoses) and divert them to either the outlet ports (C1 – C4) with spool in position “0”, when the solenoid is de-energized, or to the outlet ports (C2 – C3) with spool in position “1”, when the solenoid is energized.

With the coil de-energized, the return spring (3) pushes back the spool (2) and holds it in position “0”.

The coil (4) is fastened to the tube by the ring nut (6).

The manual override (6) allows to shift the spool (2) also in case of voltage shortage.

Hydraulic / pneumatic pilot control for spool shifting is available upon request.

Technical data

General		
Valve weight	kg (lbs)	1.08 (2.38)
Mounting position		unrestricted
Ambient Temperature	°C (°F)	–30....+90 (-22....+194) (NBR seals)
Hydraulic		
Maximum pressure with external drain (“E” type)	bar (psi)	310 (4500)
Maximum pressure with internal drain (“I” type)	bar (psi)	250 (3625)
Maximum inlet flow	l/min (gpm)	25 (6.6)
Hydraulic fluid		
General properties: it must have physical lubricating and chemical properties suitable for use in hydraulic systems such as, for example:		Mineral oil based hydraulic fluids HL (DIN 51524 part 1). Mineral oil based hydraulic fluids HLP (DIN 51524 part 2). For use of environmentally acceptable fluids (vegetable or polyglycol base) please consult us.
Fluid Temperature	°C (°F)	–30....+100 (-22....+212) (NBR seals)
Permissible degree of fluid contamination		ISO 4572: $\beta_x \geq 75$ X = 12...15 ISO 4406: class 20/18/15 NAS 1638: class 9
Viscosity range	mm ² /s	5....420
Internal leakage with 100 bar (1450 psi) secondary pressure at C	cc/min (in ³ /min)	min.7 (0.43) max. 15 (0.74)

4 **L710... (VS120A-VS125A-VS129A)** | 6/2 ways/positions flow diverters
 Technical data

Electrical						
Voltage type	DC					
Voltage tolerance against ambient temperature	See characteristic curve page 5					
Duty Cycle	See characteristic curve page 5					
Coil wire temperature not to be exceeded	°C (°F)	180 (356)				
Insulation class	H					
Compliance with	Low Voltage Directive LVD 73/23/EC (2006/95/EC), 2004/108/EC					
Coil weight with connection EN 175301-803	kg (lbs)	0.18 (0.40)				
Voltage	V	12	24	48	96	205
Voltage type		DC	DC	DC	DC	DC
Power consumption	W	20	20	20	20	20
Current (nominal at 20 °C (68 °F))	A	1.62	0.84	0.45	0.21	0.01
Resistance (nominal at 20 °C (68 °F))	Ω	7.4	28.4	106.4	451	2062

Note

For applications with different specifications consult us

Code	Voltage (V)	Connector type	Coil description	Marking	Coil Mat no.
OB 01	12 DC	EN 175301-803 (Ex. DIN 43650)	D3601 12DC	12V DC	R901393412
OB 03	12 DC	AMP JUNIOR	D3603 12DC	12V DC	R901435507
OB 04	12 DC	AMP JUNIOR Horizontal	D3604 12DC	12V DC	R901395031
OB 07	12 DC	DEUTSCH DT 04-2P	D3607 12DC	12V DC	R901394397
OC 01	24 DC	EN 175301-803 (Ex. DIN 43650)	D3601 24DC	24V DC	R901393577
OC 03	24 DC	AMP JUNIOR	D3603 24DC	24V DC	R901435494
OC 04	24 DC	AMP JUNIOR Horizontal	D3604 24DC	24V DC	R901395035
OC 07	24 DC	DEUTSCH DT 04-2P	D3607 24DC	24V DC	R901394399
OD 01	48 DC	EN 175301-803 (Ex. DIN 43650)	D3601 48DC	48V DC	R901394117
OU 01	96 DC	EN 175301-803 (Ex. DIN 43650)	D3601 96DC	96V DC	R901394229
AH 01	205 DC	EN 175301-803 (Ex. DIN 43650)	D3601 205DC	205V DC	R901394231

Note

For further versions (i.e. cable single lead) contact factory.

Characteristic curves

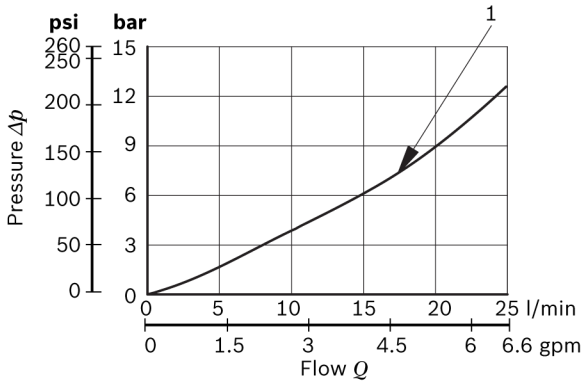

Flow path	Curve no.
P1 > C1	1
P1 > C2	1
P2 > C3	1
P2 > C4	1

Measured with hydraulic fluid ISO-VG32 at 45° ±5 °C (113° ±9 °F); ambient temperature 20 °C (68 °F).

DI-DE performance limits

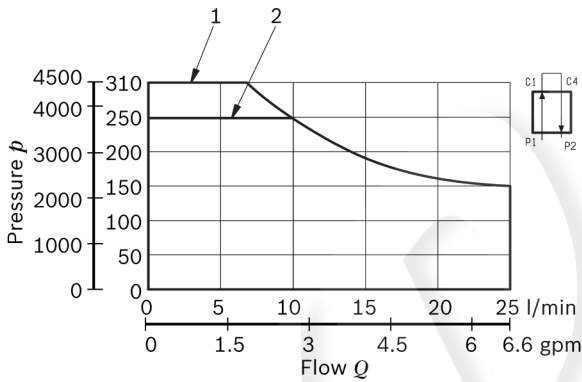

Drain type	Curve No.
External (-E-)	1
Internal (-I-)	2

Flow across both ways: forward across P1>C1 and reverse across C4>P2

Voltage tolerance against ambient temperature; duty cycle 100%

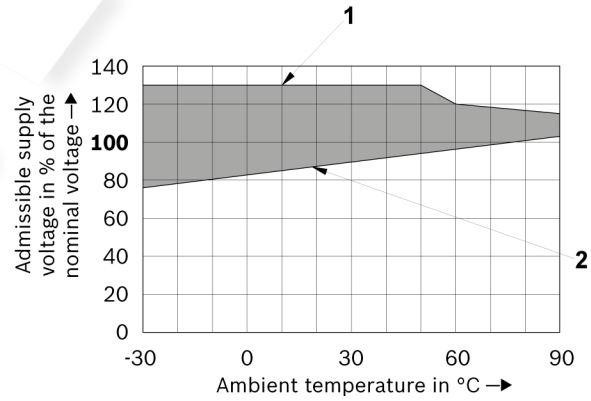

Description	Curve No.
Maximum Voltage	1
Minimum Voltage	2
Admissible supply voltage range	-

External dimensions and fittings for VS120A and VS125A

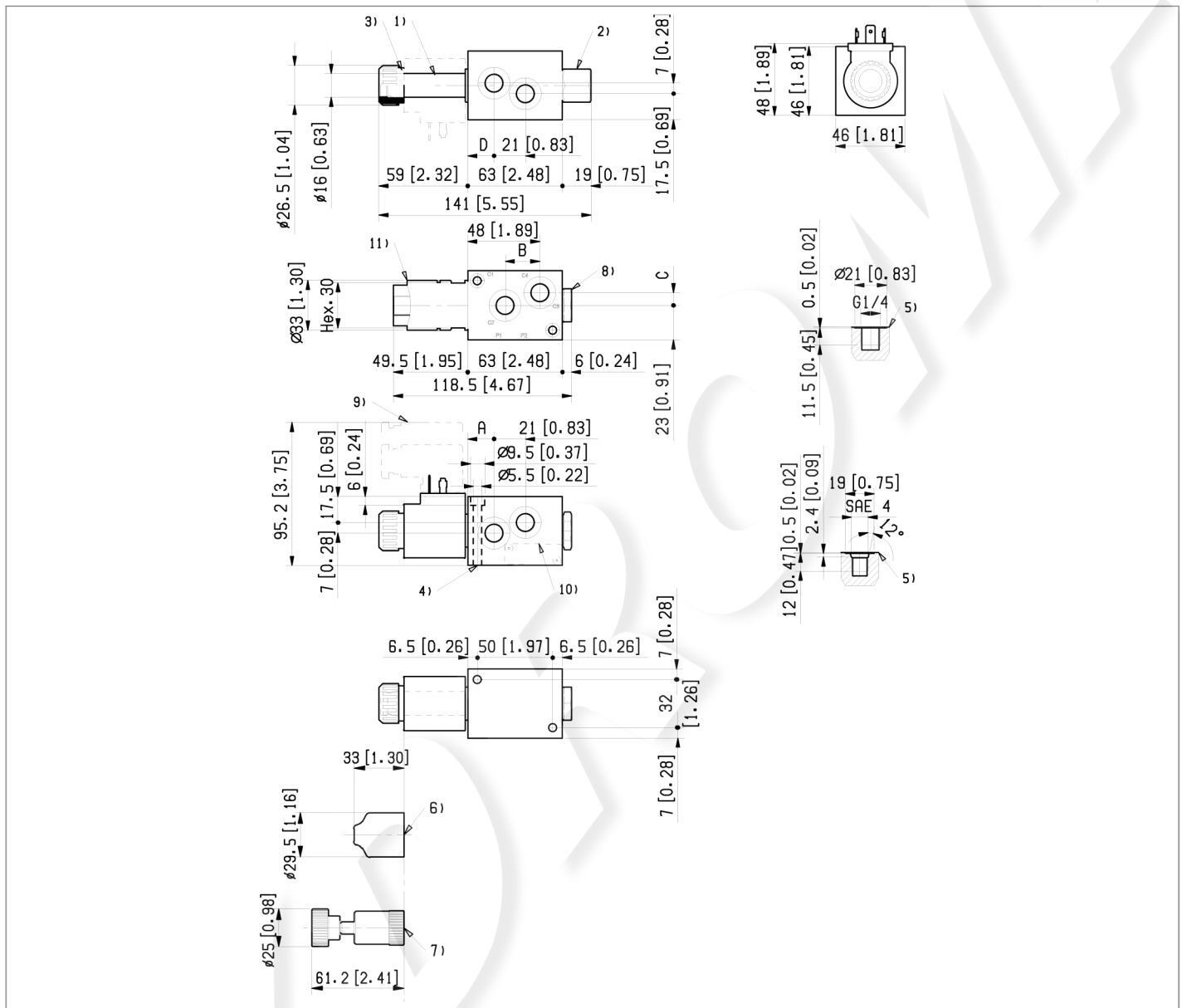

Measure	VS120 (G1/4)	VS125 (SAE 4)
A mm (inch)	17.5 (0.69)	16.5 (0.65)
B mm (inch)	23 (0.91)	22.5 (0.89)
C mm (inch)	8.5 (0.33)	7.5 (0.30)
D mm (inch)	17.5 (0.69)	18.5 (0.73)

- 1** Solenoid tube \varnothing 16mm (0.63inch).
- 2** External drain plug available with G1/4 and SAE4 port.
- 3** Ring nut for coil locking \varnothing 26,5 mm (1,04inch).
Torque 3 – 4 Nm (2.2 – 3.0 ft-lb).
- 4** Two through holes for installation. Recommended screws M5 with strength class DIN 8.8. Torque 5-6Nm(3.6-4.4 ft-lb).
- 5** Ports P1, P2, C1, C2, C3, C4.
- 6** Optional push-button type manual override for spool opening: it is pressure stuck to the ring nut for coil locking.
Mat no. R930059524.
- 7** Optional screw type manual override for spool opening: it is screwed torque 6-7Nm (4.4-5.2 ft-lb) to the tube as replacement of the coil ring nut. Mat no. R930059561.
- 8** Plug for version with internal drain.
- 9** Minimum clearance needed for connector removal (Ref. RE18325-90 Type1 - R934004344).
- 10** Identification label.
- 11** Hydraulic, or pneumatic pilot connector.

External dimensions and fittings for VS129A

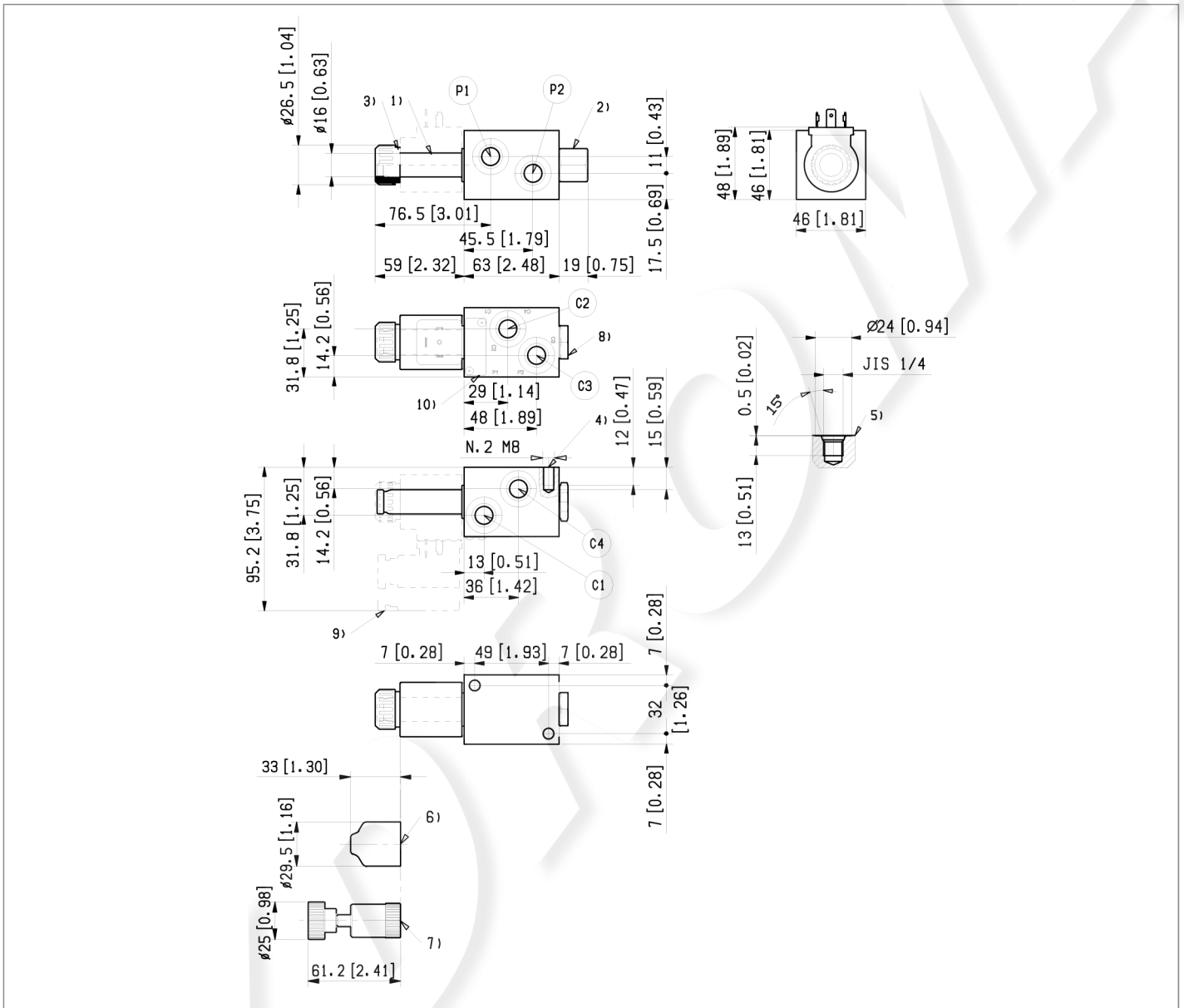

- 1 Solenoid tube \varnothing 16mm (0.63inch).
- 2 External drain plug available with G1/4 and SAE4 port.
- 3 Ring nut for coil locking \varnothing 26,5 mm (1,04inch).
Torque 3 – 4 Nm (2.2 – 3.0 ft-lb).
- 4 Four through holes for installation. Recommended screws M5 with strength class DIN 8.8. Torque 5-6Nm(3.6-4.4 ft-lb).
- 5 Ports P1, P2, C1, C2, C3, C4.
- 6 Optional push-button type manual override for spool opening: it is pressure stuck to the ring nut for coil locking.
Mat no. R930059524.
- 7 Optional screw type manual override for spool opening: it is screwed torque 6-7Nm (4.4-5.2 ft-lb) to the tube as replacement of the coil ring nut. Mat no. R930059561.
- 8 Plug for version with internal drain.
- 9 Minimum clearance needed for connector removal (Ref. RE18325-90 Type1 - R934004344).
- 10 Identification label.

Electric connection

