

Part number:

**HYDROMA**

HYDRAULICKÉ SYSTÉMY

**HIDROMA  
SYSTEMS**

UKŁADY HYDRAULICZNE

**HYDROMA**

ГИДРАВЛИЧЕСКИЕ СИСТЕМЫ

# EIPS 3

## INTERNAL GEAR PUMPS



# Internal gear pump Type EIPS 3 with constant displacement volume

# EIPS 3

## Characteristics

- Internal gear pump with axial and radial gap compensation
- Radial compensation with segments
- Pressure cover
- Field of application: Mobile hydraulic systems, e.g. for fork lifts, industrial hydraulic
- Direct fixture
- SAE-B-Flange with cylindrical shaft end
- Long time life
- Low pulsation (pressure pulsation ~ 2%)

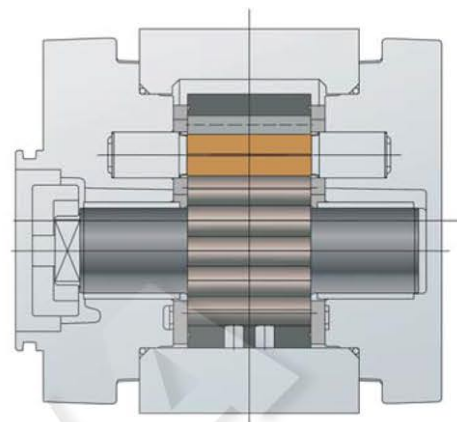
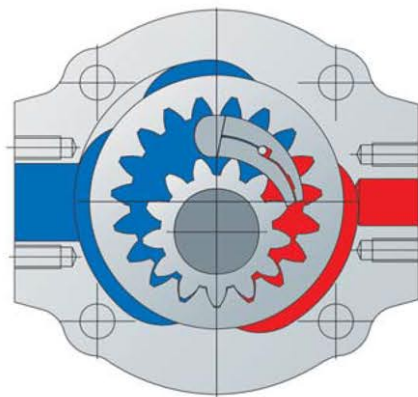

## Technical Data:

| Rated Size NG  | 020   | 025                  | 032         | 040            | 050         |
|--|---|----------------------|-------------|----------------|-------------|
| Spec. volume $V_{th}$ [cm <sup>3</sup> /rev]**         | 20.0  | 24.8                 | 32.1        | 40.1           | 50.3        |
| Continuous operating pressure [bar]                    | 250   |                      |             |                |             |
| Peak operating pressure [bar] max.10sec.15% duty cycle | 320   |                      | 300         |                | 280         |
| Cut-in pressure peak 100 ms [bar]                      | 350   |                      | 325         |                | 300         |
| Max. speed [min <sup>-1</sup> ]                        | 3,600   | 3,200                | 3,000       | 2,500          | 1,800       |
| Nominal speed [min <sup>-1</sup> ]                     | 200 – 3,600   | 200 – 3,200          | 200 – 3,000 | 100 – 2,500    | 100 – 1,800 |
| Operating viscosity [mm <sup>2</sup> /s]               | 10 – 300  |                      |             |                |             |
| Starting viscosity [mm <sup>2</sup> /s]                | 2,000   |                      |             |                |             |
| Operating temperature [°C]                             | -20 to +100   |                      |             |                |             |
| Operating medium                                       | HL – HLP DIN 51 524 part 1/2  |                      |             |                |             |
| Max. medium temperature [°C]                           | 120   |                      |             |                |             |
| Min. medium temperature [°C]                           | -40   |                      |             |                |             |
| Max. ambient temperature [°C]                          | 80  |                      |             |                |             |
| Min. ambient temperature [°C]                          | -40   |                      |             |                |             |
| Max. admission pressure (intake side) [bar]            | 2 bar absolute  |                      |             |                |             |
| Min. admission pressure (intake side) [bar]            | 0.8 bar absolute (Start 0.6)  |                      |             |                |             |
| Weight appr. [kg]:                                     | 4.9   | 5.3                  | 5.5         | 5.8            | 6.3         |
| Degree of filtration                                   | Class 20/18/15 due to ISO 4406  |                      |             |                |             |
| Life expectancy  | 10 x 10 <sup>6</sup> LW against peak operating pressure (Industrialversion with cylindrical shaft)<br>1 x 10 <sup>6</sup> LW against peak operating pressure (Mobileversion with oldham coupling) |                      |             |                |             |
| Efficiency $\eta_{vol}$ :                              | 93  | 93                   | 94          | 95             | 95          |
| Efficiency $\eta_{hm}$ :                               | 91  | 92                   | 92          | 93             | 93          |
| Pump noise* (measured in sound chamber) dB[A]          | 62  | 63                   | 64          | 65             | 66          |
|  | n = 1.450   | $\Delta p = 250$ bar | T = 50 °C   | Medium: HLP 46 |             |
|  | *Measured in anechoic room of Eckerle Hydraulic Division; Axial microphone distance 1.0 m   |                      |             |                |             |

\*\* Due to manufacturing tolerances the displacement volume could vary



## Pump with oldham coupling

Order example: EIPS3 - \_\_\_ LN33-1X

| NG  | a    | b     | c     |
|-----|------|-------|-------|
| 020 | 60.3 | 131   | 106.5 |
| 025 | 63.5 | 137.5 | 113   |
| 032 | 68.5 | 147.5 | 123   |
| 040 | 74   | 158,5 | 134   |
| 050 | 81   | 172,5 | 148   |

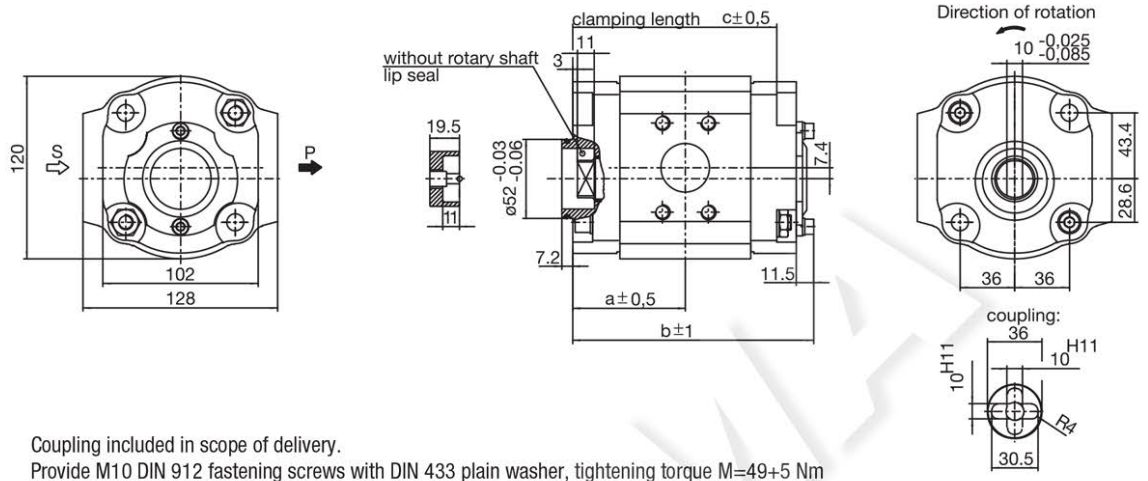

Coupling included in scope of delivery.  
Provide M10 DIN 912 fastening screws with DIN 433 plain washer, tightening torque  $M=49+5$  Nm

## Pump with SAE-B-2-hole flange and splint shaft

Order example: EIPS3 - \_\_\_ RL23-1X

| NG  | a    | b     |
|-----|------|-------|
| 020 | 79.3 | 150   |
| 025 | 82.5 | 156.5 |
| 032 | 87.5 | 166.5 |
| 040 | 93   | 177.5 |
| 050 | 100  | 191.5 |

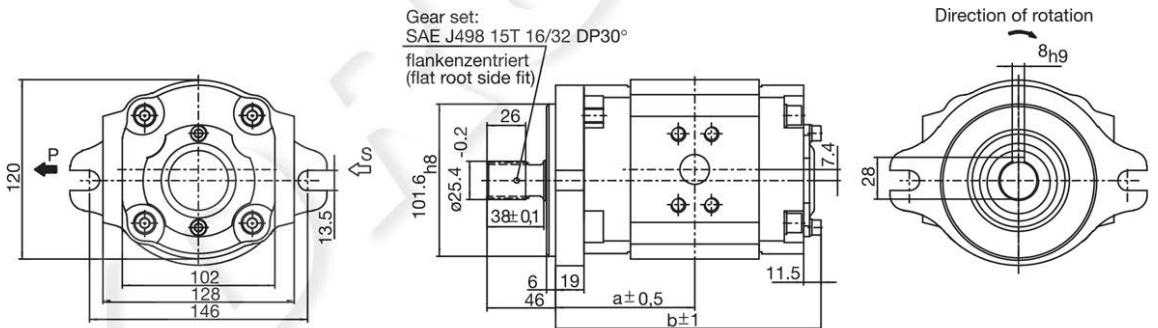

## Pump with SAE-B-2-hole flange and cylindrical shaft

Order example: EIPS3 - \_\_\_ RK23-1X

| NG  | a    | b     |
|-----|------|-------|
| 020 | 79.3 | 150   |
| 025 | 82.5 | 156.5 |
| 032 | 87.5 | 166.5 |
| 040 | 93   | 177.5 |
| 050 | 100  | 191.5 |

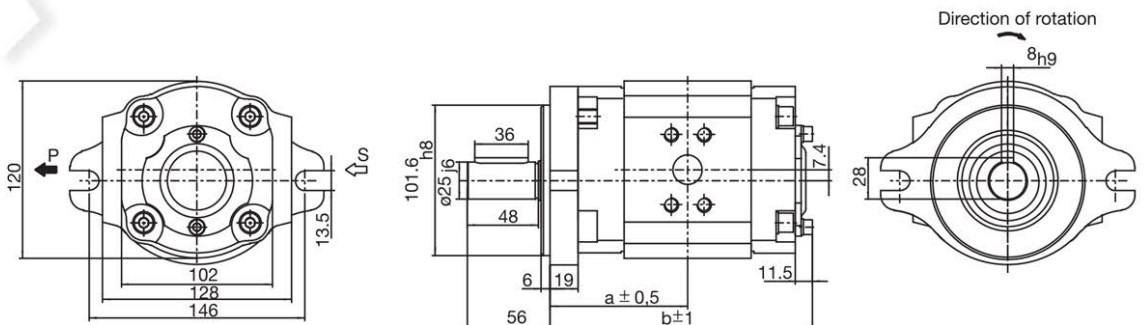

# Dimensions Ordering code

# EIPS 3

Doublepump with SAE-2-hole flange and cylindrical shaft

Order example: EIPS3 - \_\_ \_RK23-1X  
EIPS3 - \_\_ \_RP33-1X

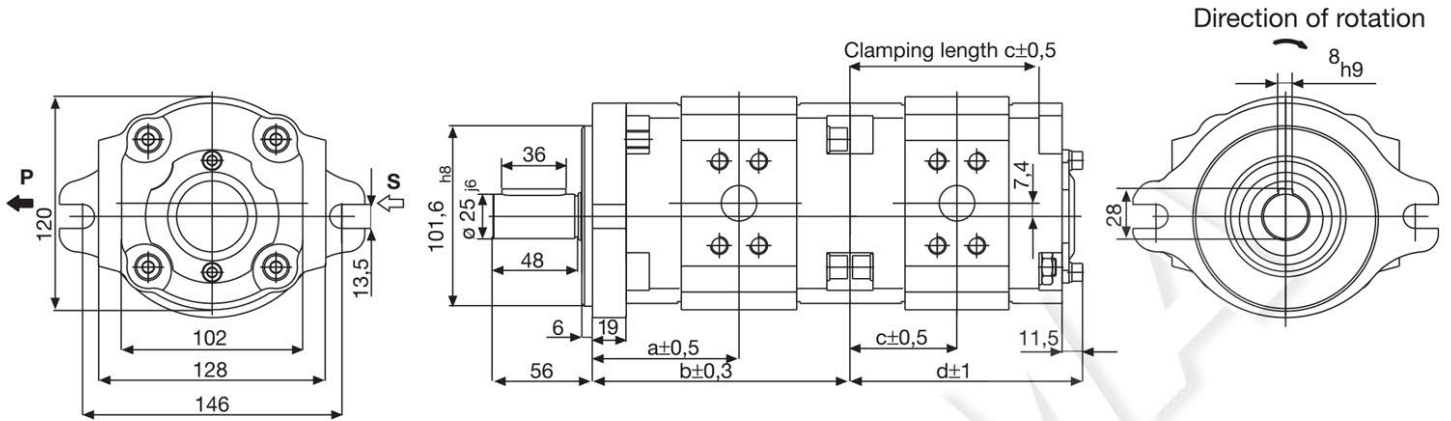

| NG  | a    | b     | c    | d     |
|-----|------|-------|------|-------|
| 020 | 79.3 | 138.5 | 60.3 | 131   |
| 025 | 82.5 | 145   | 63.5 | 137.5 |
| 032 | 87.5 | 155   | 68.5 | 147.5 |
| 040 | 93   | 166   | 74   | 158.5 |
| 050 | 100  | 180   | 81   | 172.5 |

## Ordering code

**EIP S3-032RK23-10 S123**

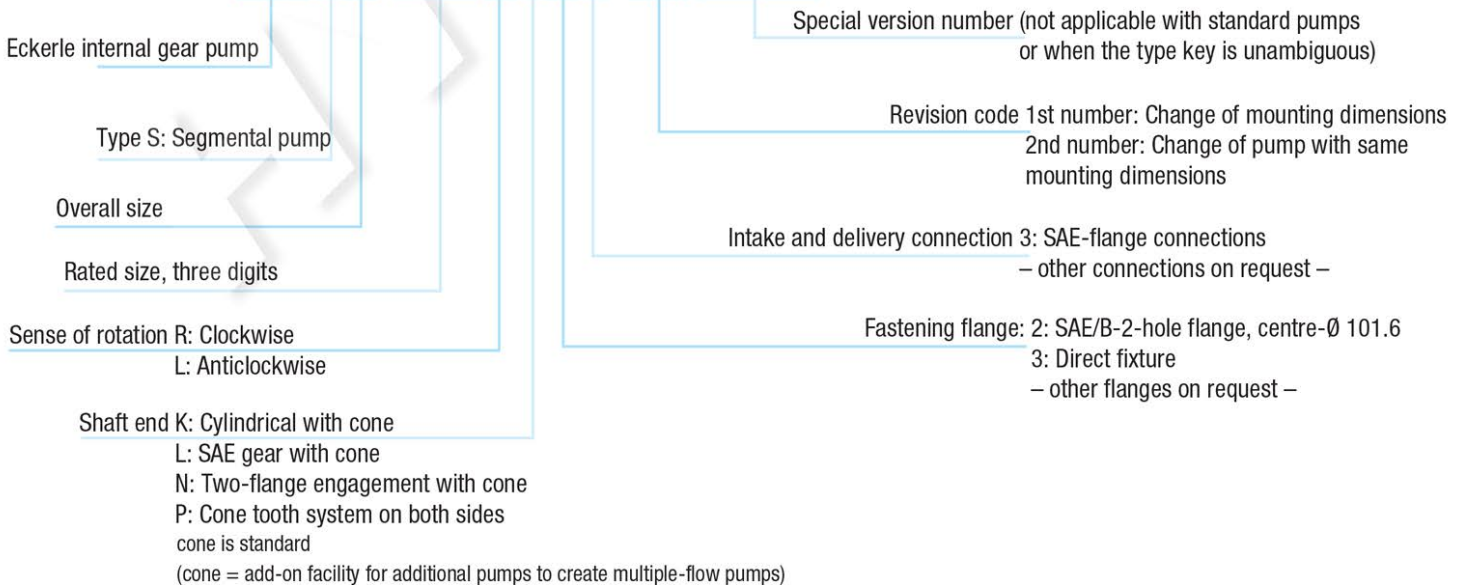

## SAE flange

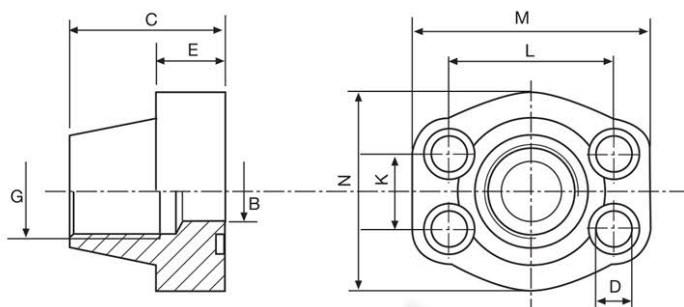

| Type             | Article number | K    | L    | G      | B  | C  | D    | E  | M  | N  | p max   | Bolts    | O-Ring     | Weight |
|------------------|----------------|------|------|--------|----|----|------|----|----|----|---------|----------|------------|--------|
| EFG3/4-SAE34-C   | 0707040027     | 22.2 | 47.6 | G3/4"  | 19 | 36 | 10.5 | 18 | 66 | 52 | 344 bar | M10 x 35 | 24.99x3.53 | 0.39   |
| EFG11/4-SAE114-C | 0707040029     | 30.2 | 58.7 | G11/4" | 32 | 41 | 11.5 | 21 | 80 | 72 | 279 bar | M10 x 40 | 37.69x2.53 | 0.66   |

## SAE flange according DIN 3901

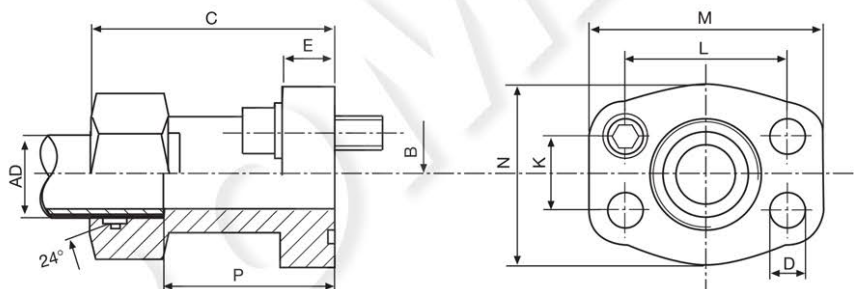

| Type            | Article number | K    | L    | AD | B  | C  | D  | E  | P  | M  | N  | pmax    | Bolts    | O-Ring     | Weight |
|-----------------|----------------|------|------|----|----|----|----|----|----|----|----|---------|----------|------------|--------|
| V-AD22-SAE34-C  | 0707040031     | 22.2 | 47.6 | 22 | 19 | 60 | 11 | 14 | 51 | 66 | 52 | 344 bar | M10 x 35 | 24.99x3.53 | 0.35   |
| V-AD35-SAE114-C | 0707040033     | 30.2 | 58.7 | 35 | 30 | 65 | 11 | 16 | 56 | 80 | 72 | 160 bar | M10 x 40 | 37.69x2.53 | 0.72   |

## Order example

### EIPS3 - 020 RK 23 - 1X

Segmental pump overall size 3 with 20 cm<sup>3</sup>/rev., clockwise rotation, cylindrical shaft with cone, SAE/B-2-hole flange connection, SAE flange connection, revision code 10

## Intake and delivery connections due to SAE J518C

### Intake connection

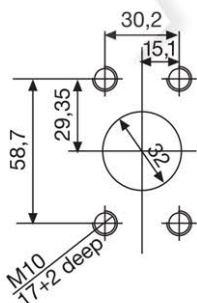

### Delivery connection

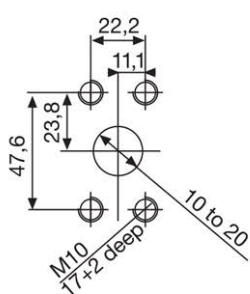

All dimensions stated in mm  
– other connections on request –



## Volumetric flow

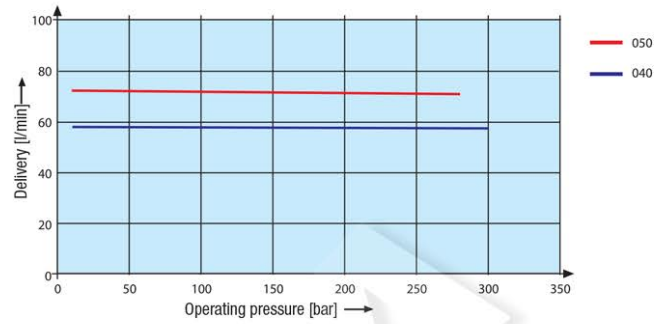
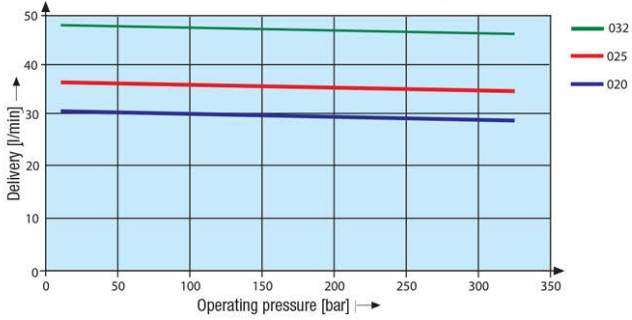

## Efficiency

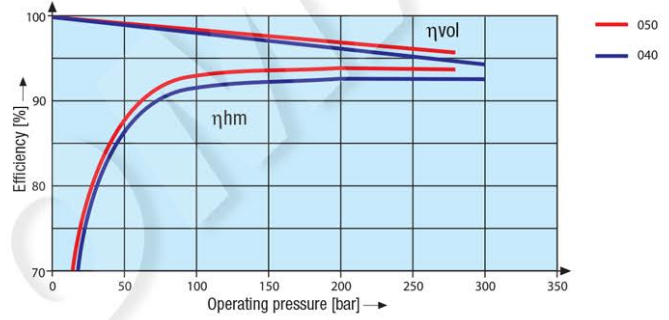
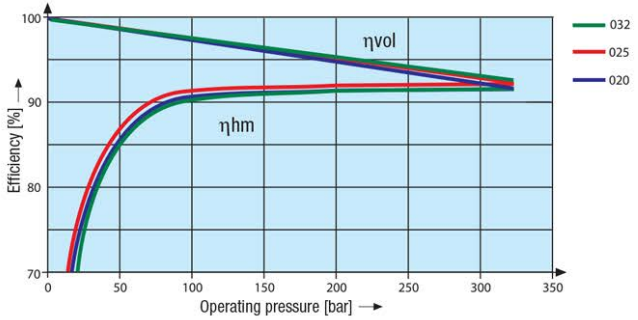

## Drive power

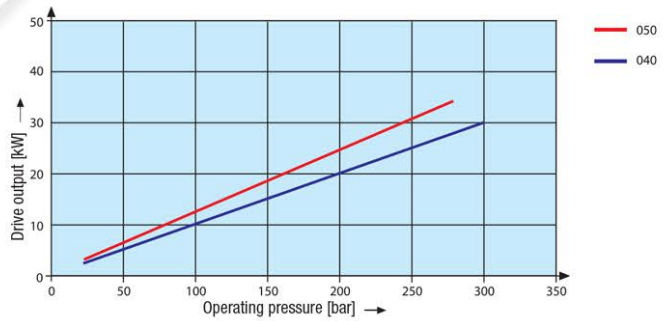
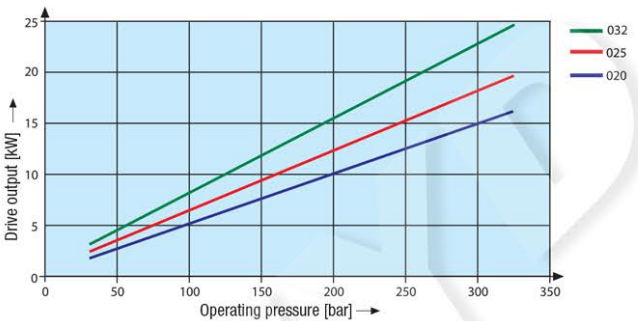

## Sound pressure level

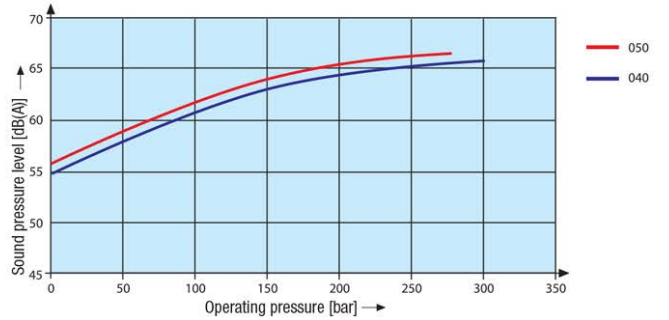
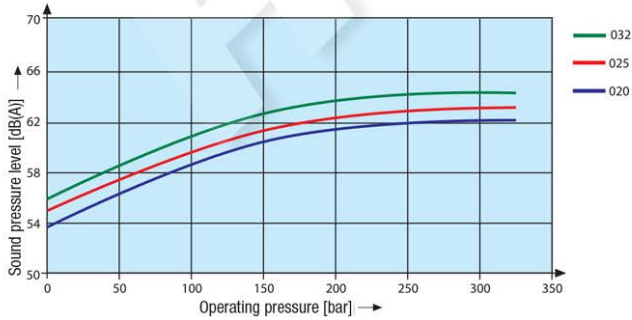

Measurement conditions: Speed 1450 rpm, viscosity 46 mm<sup>2</sup>/sec., operating temperature 40° C

Sound pressure measured in low-reflection anechoic room in accordance with DIN 45 635 sheet 26;

Microphone distance 1.0 m axial.

### Commissioning

- Check whether the unit has been carefully and correctly mounted.
- Fill with pressure fluid only using a filter with the required minimum retention rate.
- Observe the arrow indicating the correct sense of rotation.
- Start up the pump in no-load operation and run without pressure for a few seconds to ensure sufficient lubrication.
- Never allow the pump to run without oil.
- The pump has to be bleed before building up pressure against a valve. Wear is covered by running dry.
- If the pumped oil still contains bubbles of air after appr. 20 seconds, investigate the cause.

Once the target operating values have been reached, check the pipe connections for leaks. Also check the operating temperature.

### Project processing instructions

When using internal gear pumps, we recommend paying particular attention to the following information:

#### Characteristic values

All specified characteristic values are dependent upon production tolerances and apply under certain outline conditions. Please note that variance is accordingly possible, and that certain outline conditions (such as viscosity or temperature) and also characteristic values can alter.

#### Characteristic curves

When configuring the drive motor, please pay attention to the maximum possible application data as indicated in the characteristic curves on page 6.

### Venting

- Prior to initial commissioning, we recommend filling the pump housing with oil. This enhances operating safety and prevents wear in the event of unfavourable mounting conditions.
- On initial commissioning, drain off oil containing bubbles during pressure-less circulation of the oil by carefully opening the pressure flange (it may be advisable to provide a splash guard). Only when the emerging oil is free of bubbles should the screw union be tightened with the specified tightening torque.

### General

- Pumps supplied by us have been performance and function tested. Any attempts to modify the pump in any way will result in loss of warranty cover!
- Repairs may only be performed by the manufacturer or by authorized dealers and branches. No warranty can be accepted for unauthorized repairs.

### Noise

The sound pressure level values specified on page 6 are measured on the basis of DIN 45 635, sheet 26. This means that only the noise emission of the pump itself is indicated. Environmental influences (installation location, pipework etc.) are not taken into consideration. These values apply in each case to only one pump.

In the case of internal gear pumps, the excitation of valves, pipelines, machine parts etc. is minimal due to the low discharge flow pulsation (appr. 2 – 3%).

Despite this, however, under unfavourable circumstances the sound pressure level at the mounting location of the unit can be 5 to 10 dB(A) higher than the value for the pump itself.

### Important remarks

- Installation, maintenance and repair of pumps may only be performed by suitably qualified and authorized personnel who have received the relevant instruction.
- Pumps may only be operated in accordance with the specified ratings.
- The pump may only be operated when in flawless condition.
- Before performing any work on the pump, always depressurize the system.
- Any conversions or modifications of the pump which affect safety or functional characteristics are not permissible.
- Ensure that the necessary protective gear (such as coupling safeguards) is in place and that existing safeguards are not removed.
- Always check the firm fit of all fastening screws (observe the specified tightening torque).
- Ensure that the generally applicable safety and accident prevention regulations are observed.

### Drive system

Electric motor + pump mount + coupling + pump

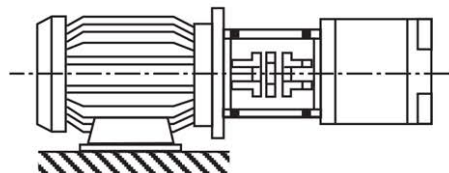

- No radial or axial forces may be permitted to act on the pump drive shaft.
- The motor and pump must be precisely aligned.
- Always use a coupling which will permit compensation for any shaft displacement.
- When mounting the coupling, avoid applying axial force, i.e. never attempt to press or knock into place using a hammer or similar instrument.

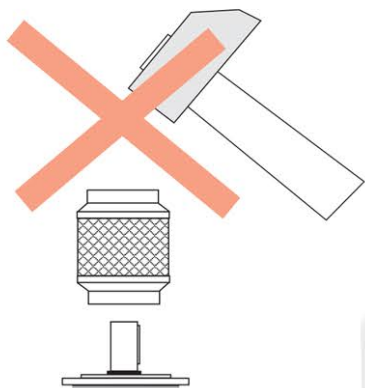

### Fluid tank

- Adjust the useful volume of the tank to the operating conditions.
- Never exceed the admissible fluid temperature. If necessary, provide a cooler.

### Pipes and connections

- Remove the protective plug at the pump
- We recommend using seamless precision steel pipes in compliance with DIN 2391 and detachable pipe connectors.
- Select a suitable clear width for pipes and connections (intake speed max. 1–1.5 m/s).
- Absolute admission pressure max. 2 bar.
- Carefully clean pipelines and screw unions prior to mounting.

### Pipe routing recommendation

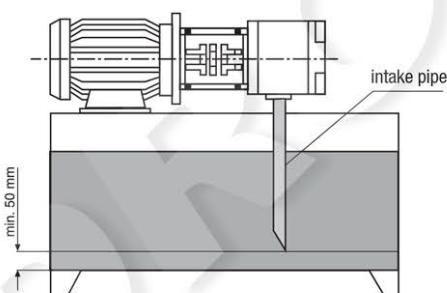

- Return line fluid must not under any circumstances be permitted to directly re-enter the system via the intake pipe, i.e. ensure the greatest possible distance between the intake and the return line pipe.
- Return line pipe has to be under oil level at all times.
- When assembling pipelines, ensure that the suction and pressure seal is completely intact.

### Filters

- Wherever possible use return or pressure filters (use suction filters only in conjunction with vacuum switches / dirt accumulation indicators).

### Pressure fluid

- We recommend using brand name hydraulic oils HL-HLP DIN 51524 part 1 + 2
- Different oil types must not be mixed, as this can result in decomposition and a reduction of lubrication capability.
- Depending on the operating conditions, the fluid must be renewed at certain intervals. When changing the fluid, the tank must be cleaned of residues.

### Mounting positions

