

Part number:

**HYDROMA**  
HYDRAULICKÉ SYSTÉMY

**HIDROMA**  
SYSTEMS  
UKŁADY HYDRAULICZNE

**HYDROMA**  
ГИДРАВЛИЧЕСКИЕ СИСТЕМЫ



# DSE3B

## DIRECTIONAL VALVE WITH PROPORTIONAL CONTROL SERIES 10

**SUBPLATE MOUNTING  
ISO 4401-03**

**p max 350 bar  
Q max 40 l/min**

### MOUNTING INTERFACE

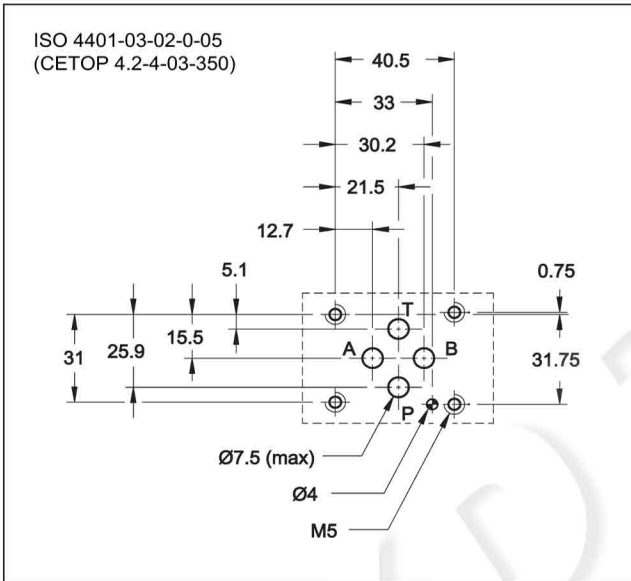

### OPERATING PRINCIPLE

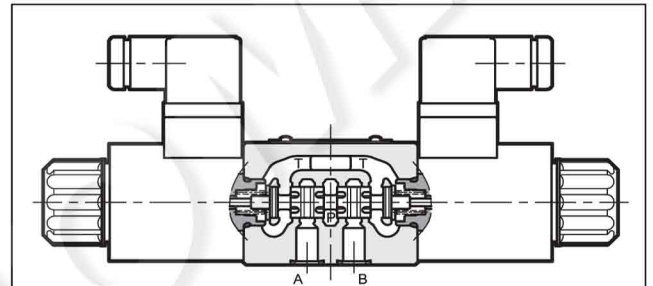

- The DSE3B valve is a directly operated directional control valve with electric proportional control and with ports, in compliance with ISO 4401-03 standards.
- It is used for directional and speed control of hydraulic actuators.
- Valve opening and hence flow rate can be modulated continuously in proportion to the current supplied to the solenoid.
- The valve can be controlled directly by a current control supply unit or combined with an external electronic card to exploit valve performance to the full (see par. 11).

**PERFORMANCES** (obtained with mineral oil with viscosity of 36 cSt at 50°C and with electronic control unit)

Max operating pressure: P - A - B ports	bar	350
T port		160
Nominal flow with $\Delta p$ 10 bar P-T	l/min	8 - 16 - 26
Step response		see chapter 5
Hysteresis (with PWM 200 Hz)	% Q <sub>max</sub>	< 6%
Repeatability	% Q <sub>max</sub>	< ± 2%
Electrical characteristics		see chapter 4
Ambient temperature range	°C	-20 / +50
Fluid temperature range	°C	-20 / +80
Fluid viscosity range	cSt	10 ÷ 400
Fluid contamination degree	According to ISO 4406:1999 class 18/16/13	
Recommended viscosity	cSt	25
Mass: single solenoid valve	kg	1,6
double solenoid valve		2,0

### HYDRAULIC SYMBOLS (typical)

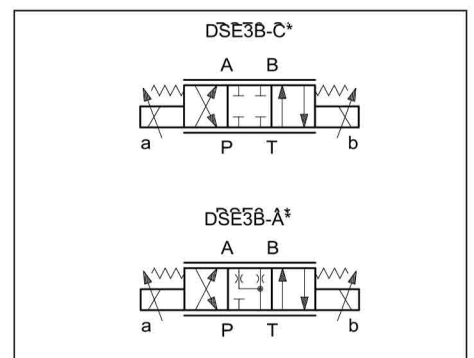

# 1 - IDENTIFICATION CODE

**D S E 3 B - / 10 - / /**

Directly operated directional control valve

Electric proportional control

Size ISO 4401-03

Spool type:  
**C** = closed centers  
**A** = open centers

Spool nominal flow (see paragraph 2)

Solenoid position (omit for configuration with two solenoids):  
**SA** = 1 solenoid on side A  
**SB** = 1 solenoid on side B

Option:  
**/ W7** = Zinc-nickel surface treatment (see **NOTE**)  
 Omit if not required

Option: manual override (see at par. 8)

Coil electrical connection:

**K1** = plug for connector type DIN 43650 (**standard**)

**K7** = plug DEUTSCH DT04-2P for male connector type DEUTSCH DT06-2S

**D12** = Nominal solenoid voltage 12V DC

**D24** = Nominal solenoid voltage 24V DC

Seals:

**N** = NBR seals for mineral oil (**standard**)

**V** = FPM seals for special fluids

Series No. (from 10 to 19 sizes and mounting dimensions remain unchanged)

**NOTE:** The standard valve is supplied with surface treatment of phosphating black.

The zinc-nickel finishing on the valve body makes the valve suitable to ensure a salt spray resistance up to 240 hours. (test operated according to EN ISO 9227 standards and test evaluation operated according to UNI EN ISO 10289 standards).

For a salt spray resistance up to 600 hours order the high corrosion resistance version.

## 1.1 - High corrosion resistance version

This version features the zinc-nickel coating on all exposed metal parts of the valve, making it resistant to exposure to the salt spray for **600 hours** (test performed according to UNI EN ISO 9227 and assessment test performed according to UNI EN ISO 10289).

The coil are specific for this version, featuring a zinc-nickel surface treatment. Electrical features at paragraph 4.

The boot manual override (CM) is installed as standard in order to protect the solenoid tube.

Follow the identification code below to order it:

**D S E 3 B - / 10 - / / W7**

Choices as in standard identification code

DC power supply

**D12** = 12 V

**D24** = 24 V

Coil electrical connection

**WK1** = plug for connector type DIN 43650

On request: plug DEUTSCH DT04-2P, for male connector type DEUTSCH DT06-2S.

Manual override:

**CM** = manual override, boot protected (**standard**)

**CK** = knob manual override

## 2 - CONFIGURATIONS

Valve configuration depends on the combination of the following elements:  
number of proportional solenoids, spool type, nominal flow rate.

2 solenoids configuration:  
3 positions with spring centering

“SA” configuration: 1 solenoid on side A.  
2 positions (central + external) with  
spring centering

“SB” configuration: 1 solenoid on side B.  
2 positions (central + external) with  
spring centering

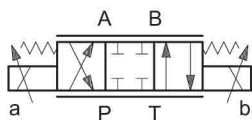

C \*

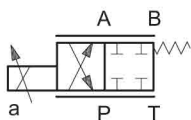

C \* SA

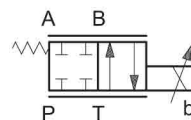

C \* SB

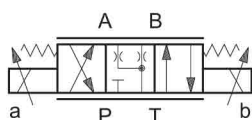

A \*

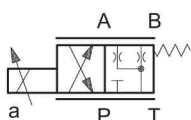

A \* SA

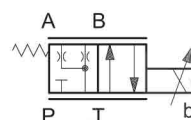

A \* SB

*	Controlled flow with $\Delta p 10$ bar P-T
08	8 l/min
16	16 l/min
26	26 l/min

### 3 - CHARACTERISTIC CURVES

(values measured with viscosity of 36 cSt at 50°C with electronic control unit)

Typical constant flow rate control curves at  $\Delta p$  according to current supply to solenoid (D24 version, maximum current 860 mA), measured for the various spool types available.

The reference  $\Delta p$  values are measured between ports P and T on the valve.

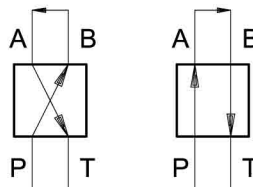

**SPOOL TYPE C08**

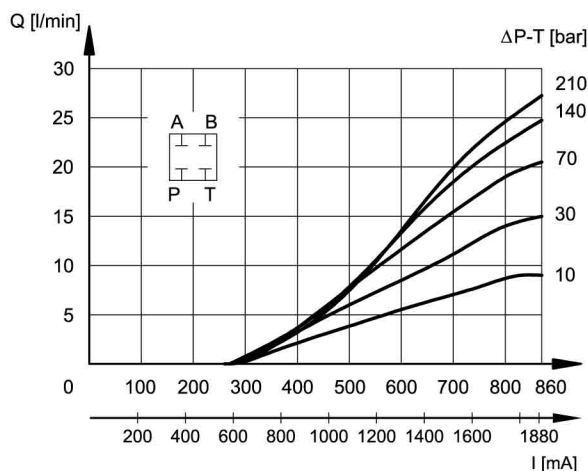

**SPOOL TYPE A08**

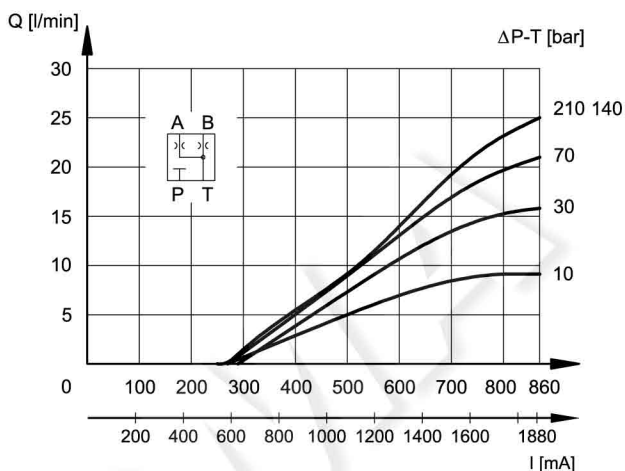

**SPOOL TYPE C16**

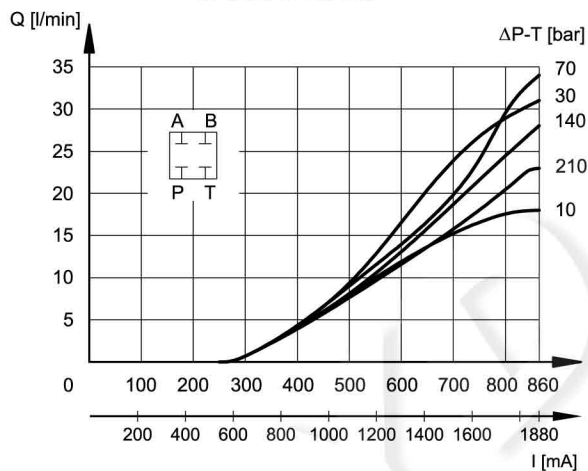

**SPOOL TYPE A16**

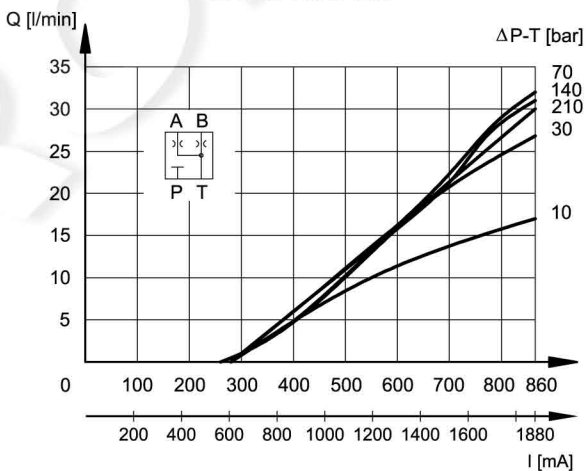

**SPOOL TYPE C26**

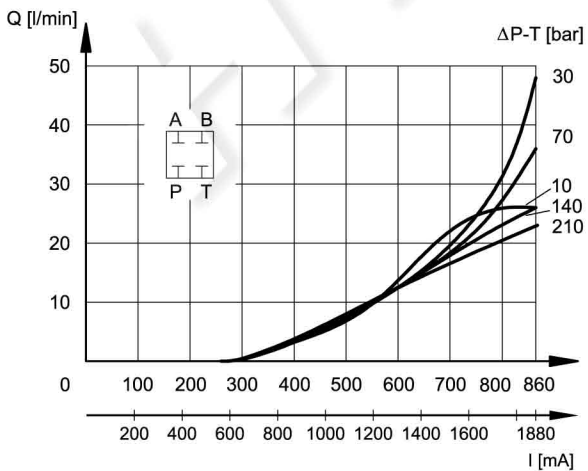

**SPOOL TYPE A26**

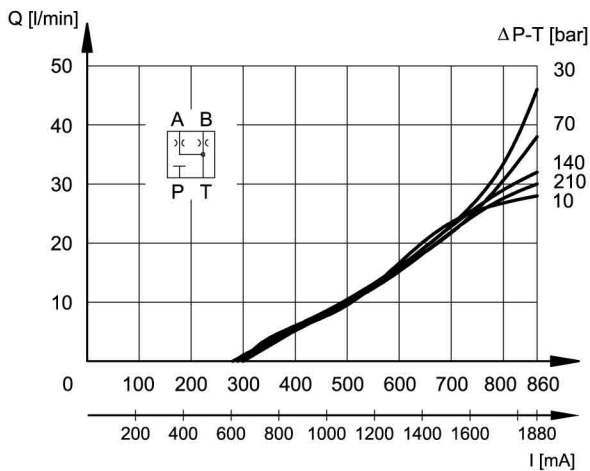

## 4 - ELECTRICAL CHARACTERISTICS

### Proportional solenoid

The proportional solenoid comprises two parts: tube and coil.

The tube, screwed to the valve body, contains the armature which is designed to maintain friction to a minimum thereby reducing hysteresis.

The coil is mounted on the tube secured by means of a lock nut.

It can be rotated through 360° depending on installation clearances.

### Protection from atmospheric agents CEI EN 60529

Plug-in type	IP 65	IP 69 K
K1 DIN 43650	x (*)	
K7 DEUTSCH DT04 male	x	x (*)

(\*) The protection degree is guaranteed only with the connector correctly connected and installed.

<b>NOMINAL VOLTAGE</b>	V DC	<b>12</b>	<b>24</b>
<b>RESISTANCE (at 20°C)</b>	Ω	4,4	18,6
<b>MAXIMUM CURRENT</b>	A	1,88	0,86
<b>DUTY CYCLE</b>	100%		
<b>ELECTROMAGNETIC COMPATIBILITY (EMC)</b>	according to 2004/108/EC		
<b>CLASS OF PROTECTION:</b> coil insulation (VDE 0580) impregnation	class H class F		

## 5 - STEP RESPONSE

(measured with mineral oil with viscosity of 36 cSt at 50°C with electronic control units)

Step response is the time taken for the valve to reach 90% of the setted positioning value, following a step change of reference signal.

The table shows typical response times tested with spool type C16 and  $\Delta p = 30$  bar P-T.

<b>REFERENCE SIGNAL STEP</b>	0 → 100%	100 → 0%
Step response [ms]		
<b>DSE3B-A*</b> <b>DSE3B-C*</b>	50	40

## 6 - ELECTRIC CONNECTIONS

Connectors for K1 connection are always delivered together with the valves.

connection for DIN 43650  
connector  
code **K1 (standard)**  
code **WK1** (W7 version only)

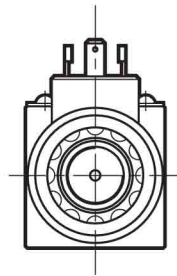
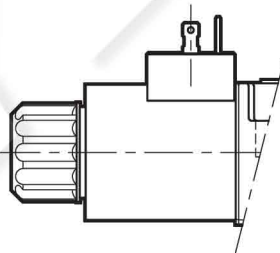

connection for  
DEUTSCH DT06-2S male connector  
code **K7**

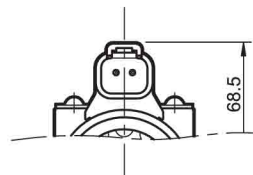

## 7 - OVERALL AND MOUNTING DIMENSIONS

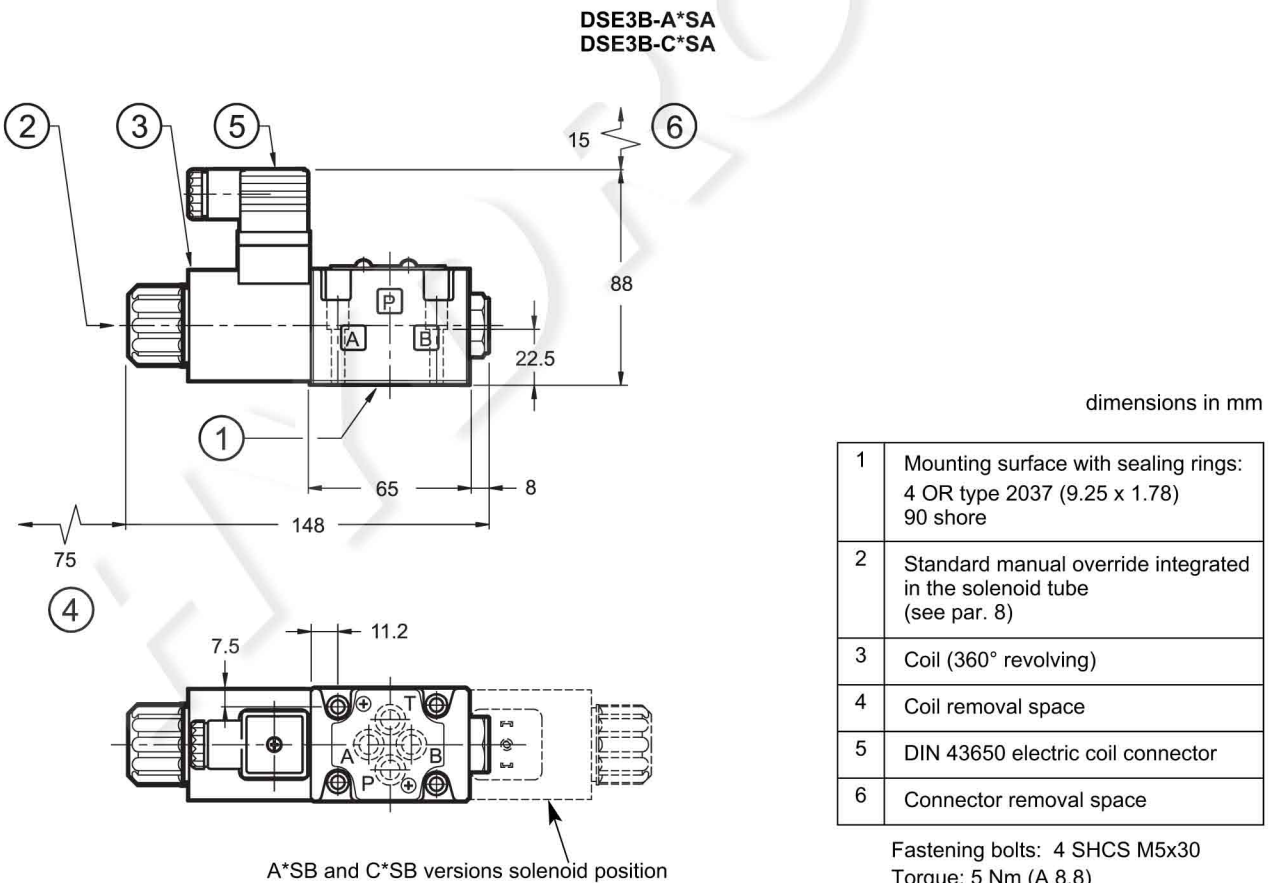
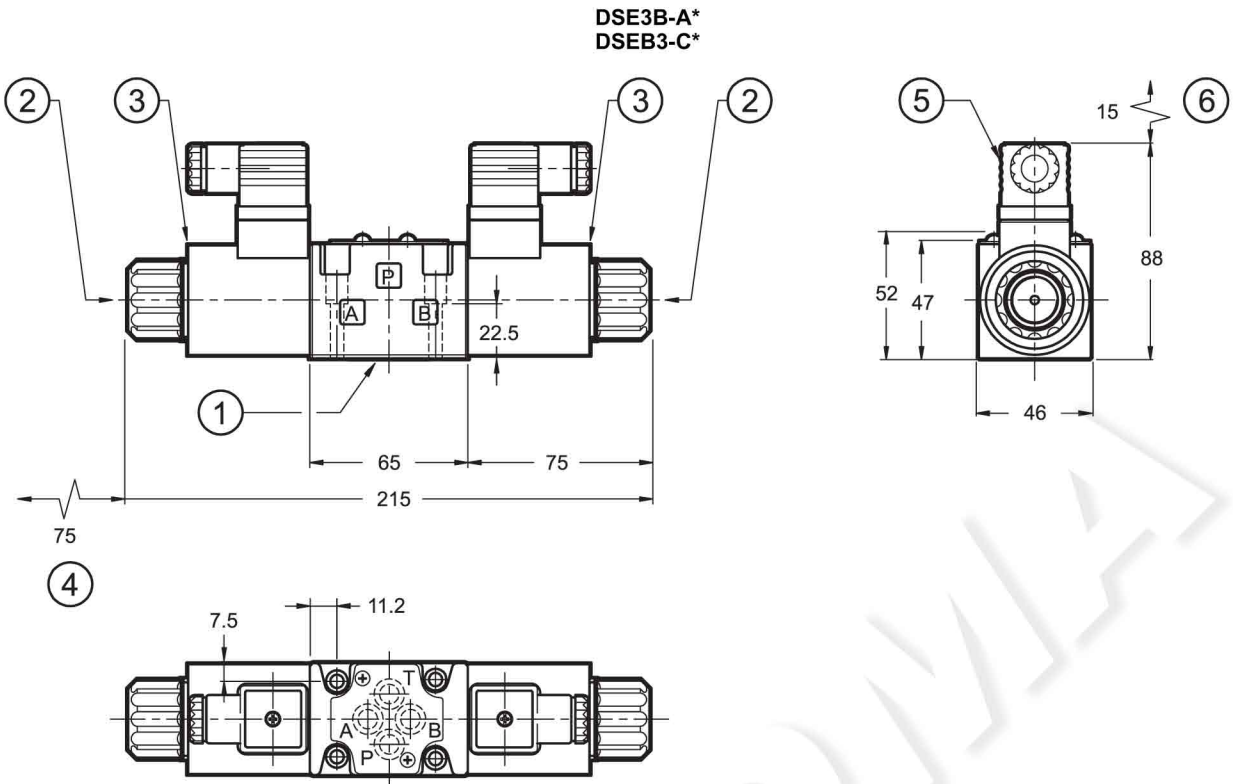

1	Mounting surface with sealing rings: 4 OR type 2037 (9.25 x 1.78) 90 shore
2	Standard manual override integrated in the solenoid tube (see par. 8)
3	Coil (360° revolving)
4	Coil removal space
5	DIN 43650 electric coil connector
6	Connector removal space

Fastening bolts: 4 SHCS M5x30  
Torque: 5 Nm (A 8.8)  
Threads of mounting holes : M5x10  
Locking ring tightening torque:  
5 ± 0.5 Nm



### 8 - MANUAL OVERRIDE

The standard valve has solenoids whose pin for the manual operation is integrated in the tube. The operation of this control must be executed with a suitable tool, minding not to damage the sliding surface.

Two different manual override version are available upon request:

- **CM** version, manual override belt protected.
- **CK** version, knob. When the set screw is screwed and its point is aligned with the edge of the knob, tighten the knob till it touches the spool: in this position the override is not engaged and the valve is de-energized. After adjusting the override, tighten the set screw in order to avoid the knob loosening.

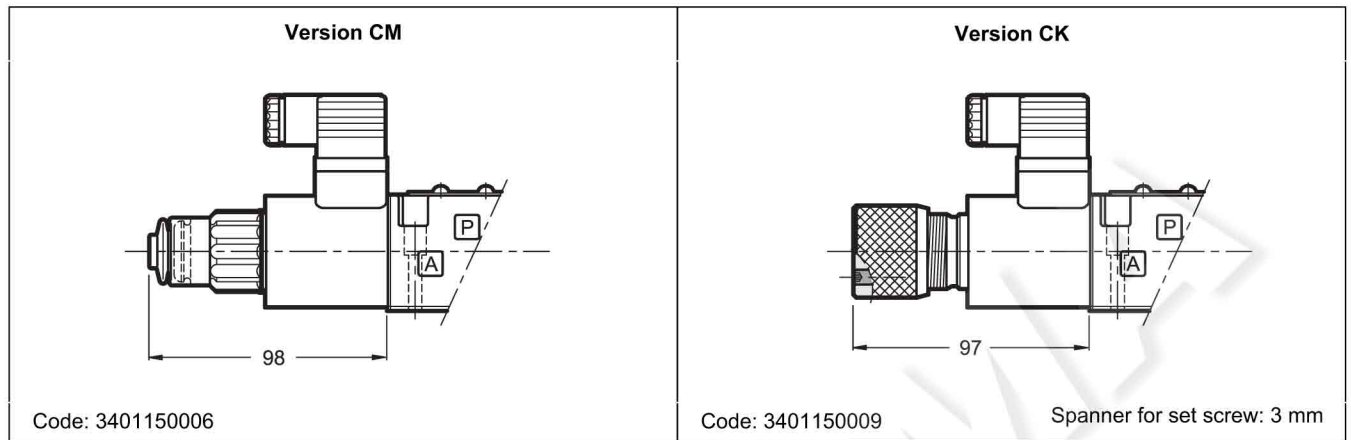

### 9 - HYDRAULIC FLUIDS

Use mineral oil-based hydraulic fluids like HL or HM type, according to ISO 6743-4. With this kind of fluids, use NBR seals type (code N). For HFDR fluids type (phosphate esters) use FPM seals (code V). For use with other kind of fluids such as HFA, HFB, HFC please consult our technical department.

Operation with fluid temperature exceeding 80°C causes premature deterioration of the quality of the fluid and seals. The physical and chemical properties of the fluid must be maintained.

### 10 - INSTALLATION

DSE3B valves can be installed in any position without impairing correct operation.

Ensure that there is no air in the hydraulic circuit.

Valves are fixed by means of screws or tie rods on a flat surface with planarity and roughness equal to or better than those indicated in the relative symbols. If minimum values are not observed fluid can easily leak between the valve and support surface.

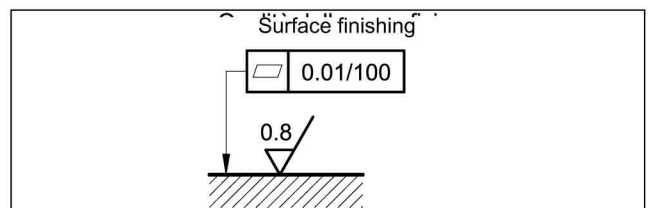

## 11 - ELECTRONIC CONTROL UNITS

### DSE3B - \*\* SA (SB)

<b>EDC-112</b>	for solenoid 24V DC	plug version	see cat. 89 120
<b>EDC-142</b>	for solenoid 12V DC		
<b>EDM-M112</b>	for solenoid 24V DC	DIN EN 50022 rail mounting	see cat. 89 250
<b>EDM-M142</b>	for solenoid 12V DC		

### DSE3B - A\*      DSE3B - C\*

<b>EDM-M212</b>	24V DC solenoids	rail mounting DIN EN 50022	see cat. 89 250
<b>EDM-M242</b>	12V DC solenoids		

## 12 - SUBPLATES

Type PMMD-AI3G ports on rear (3/8" BSP threaded)
Type PMMD-AL3G side ports (3/8" BSP threaded)