

Part number:

HYDROMA

HYDRAULICKÉ SYSTÉMY

**HIDROMA
SYSTEMS**

UKŁADY HYDRAULICZNE

HYDROMA

ГИДРАВЛИЧЕСКИЕ СИСТЕМЫ

Solenoid operated valves pilot operated poppet type
2-way normally closed
Common cavity, Size 08

VEI-16-08A-NC

OD.15 - X - 18 - Y - Z - W

RE 18323-25

Edition: 07.2021

Replaces: 01.2020



PATENT PENDING

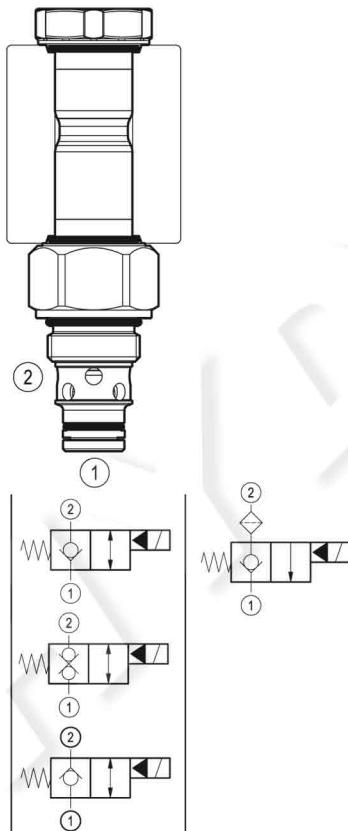

Application note:

In case of low flow function or low volumes actuators, VEI-16-08A with W=000T fast response version is especially recommended. Direct acting solenoid valves (VEDT-16-08A) are also recommended for low flow, low volume function, low volume actuators.

Technical data

New VEI-16 family incorporates a new solenoid concept providing excellent performance and enables cartridges to work in severe environment. Cartridges also incorporates advanced design of hydraulic parts providing excellent hydraulic performance.

Technical data

General	
Weight	0.15 kg (0.33 lbs)
Installation orientation	Unrestricted
Storage ambient temperature range	-40 to 100 °C (-40 to 212 °F)
Operating ambient temperature range	-30 to 90°C (-22 to 194°F) for W=0000 -30 to 75°C (-22 to 167°F) for W=000T
Salt spray test to DIN EN ISO 9227:2017-07	500h
Hydraulic	
Max. operating pressure	350 bar (5000 psi)
Flow range	0.5 - 40 l/min. (0.1 - 11 gpm) for W=0000 0.5 - 30 l/min. (0.1 - 8 gpm) for W=000T
Fatigue cycle life	2 million cycles at 350 bar 150000 cycles at 420 bar
Max. internal leakage:	5 drops/min. for X= 01,05,07 20 drops/min. for X= 31,03,09
Switching time for W=0000	Opening ≤ 50 ms Closing ≤ 100 ms
Switching time for W=000T	Opening ≤ 50 ms Closing ≤ 50 ms
Fluid temperature range	-20 to 80 °C (-4 to 176 °F)
Fluids:	Mineral-based or synthetics with lubricating properties at viscosities of 20 to 380 mm ² /s (cSt)
Installation torque	35 - 43 Nm (26 - 32 ft-lbs)
Recommended degree of fluid contamination	Nominal value max. 10 µm (NAS 8) ISO 4406 19/17/14
MTTFD	150 years see RE 18350-51
Cavity	CA-08A-2N see 18325-70
Seal kit for X=01,05,07	code RG08A2010520100 material no. R901101437
Seal kit for X=31,03,09	code RG08A2010530100 material no. R901101544
Seal kit coil and standard cap	code RG02Z0010000100 material no. R930067869
Seal kit coil and protective cap only for Y=D	code RG03Z0010000100 material no. R930067870
Other technical data	See data sheet 18350-50
Electrical	
Type of voltage	DC voltage
Coil type	D36
Supply voltage	See data sheet 18325-90
Voltage tolerance against amb.temp.	See characteristic curve
Power consumption	20 W
Type of protection	See data sheet 18325-90
Note: Coils must be ordered separately	

Ordering code

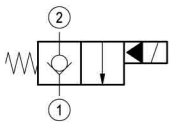
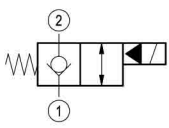
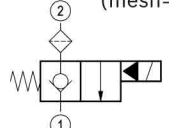
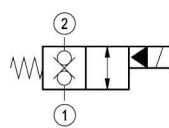
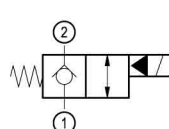
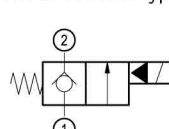
OD.15	X	18	Y	Z	W	*
Solenoid operated valves pilot operated poppet type 2-way normally closed						Series O/A to L unchanged performances and dimensions
monodirectional type						0000 = Standard 000T = Low flow - fast response only for 01, 05
						
bidirectional type						0 = With buna seal 8 = With buna seal and extra spring only for 03, 05, 31 V = With Viton seal P = With buna seal and protective cap for override version D T = With Viton seal and protective cap for override version D
						
monodirectional type with filter (mesh= 300 µm)						A = Standard D = Knob style manual override E = Pull style manual override F = Hand operated pull style manual override
						
bidirectional type						
						
bidirectional type						Common cavity: CA-08A-2N
						
monodirectional type						
						

Preferred types

Type	Material number
OD150118A000000	R930058697
OD150118D000000	R930059941
OD150518A000000	R930058427
OD150518D000000	R930058344
OD150518DP00000	R930059757
OD150718A000000	R930058338
OD150718D000000	R930058336
OD150718DP00000	R930058529
OD150118E000000	R930060958
OD150518E000000	R930060966
OD150718E000000	R930060973
OD153118A000000	R930058334

Type	Material number
OD153118D000000	R930058898
OD153118E000000	R930065030
OD150518A800000	R930063229
OD150318A000000	R930062828
OD150918A000000	R930064361
OD153118DP00000	R930066685
OD150518D800000	R930063959
OD150318D000000	R930065238
OD150918D000000	R930066189
OD150318A800000	R930065856
OD150518A800000	R930063229
OD153118A800000	R930066547

Characteristic curves

All Versions - Admissible supply voltage Vs. Ambient temperature at 100% duty cycle

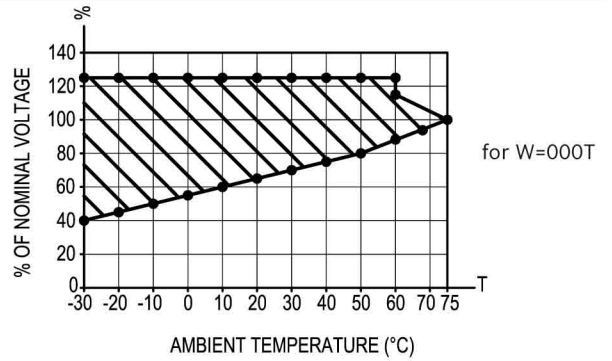
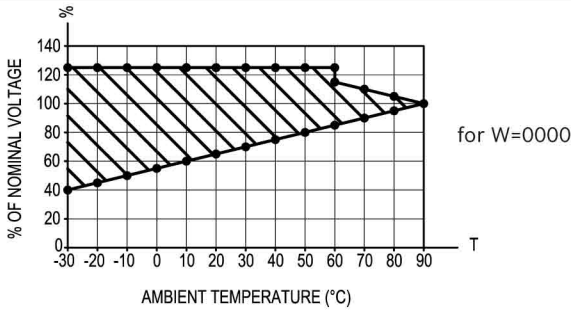

Versions 01, 05, 07 for W=0000

Version 05 with extra spring for W=0000

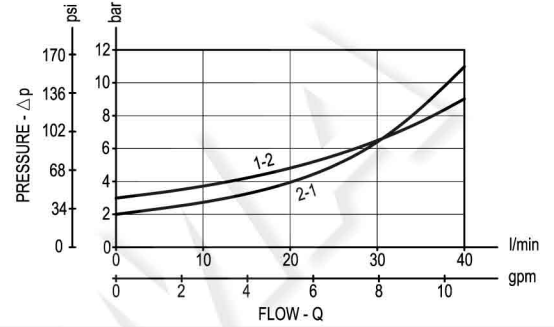
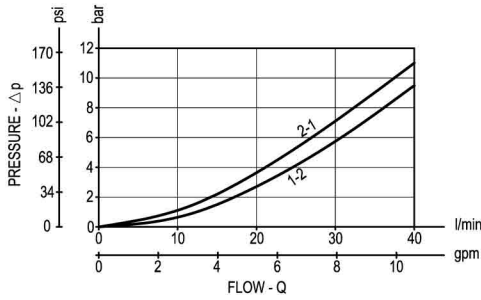

Version 31 for W=0000

Version 31 with extra spring for W=0000

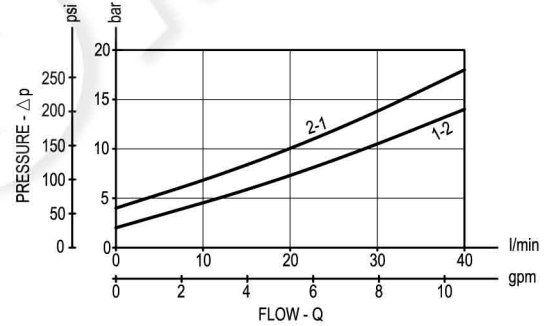
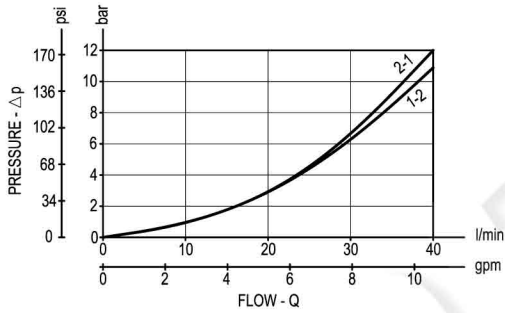

Versions 03, 09 for W=0000

Version 03 with extra spring for W=0000

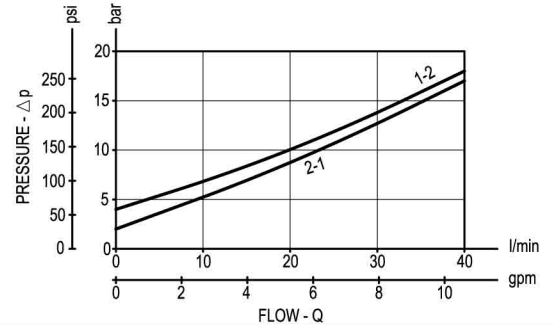
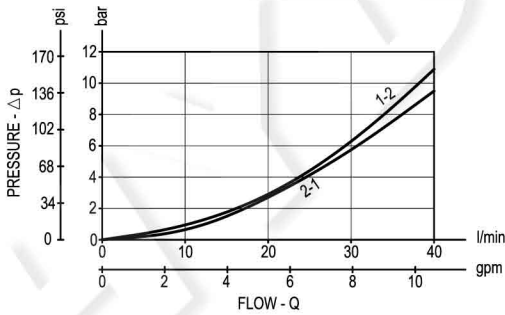

Version 5 for W=000T

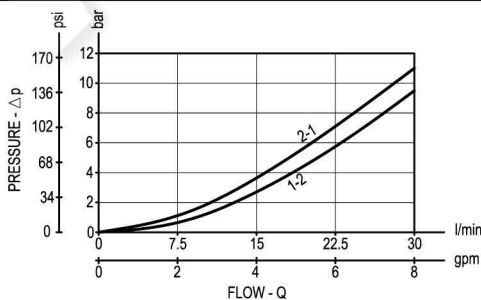

Dimensions

Solenoid operated valves, poppet 2-way normally closed

