

Part number:



RPC1-T3

PRESSURE AND TEMPERATURE COMPENSATED THREE-WAY FLOW CONTROL VALVE SERIES 41

SUBPLATE MOUNTING ISO 6263-03

p max 250 bar
Q max (see table of performances)

MOUNTING INTERFACE

ISO 6263-03-03-*97
(CETOP 4.5.2-3-03-250)

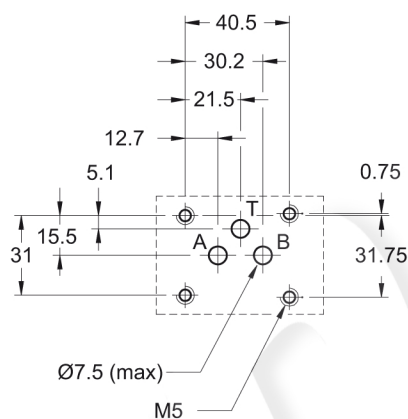

OPERATING PRINCIPLE

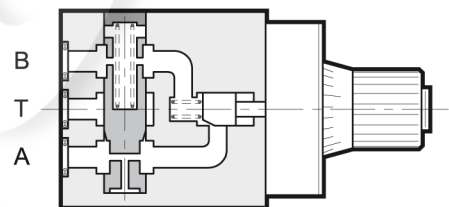

- The pressure and temperature compensated three-way flow control valves serve to control the flow sent to the actuator and to discharge it, which exceeds that required, back to tank at system pressure rather than at relief value pressure.
- The flow rate adjustment range is carried out with three turns of the knob and an indicator shows the number of turns made. A one-turn adjustment on the knob, RPC1*/M, is available upon request.
- The adjustment knob can be locked in any position in the adjustment range by a screw.

PERFORMANCES (obtained with mineral oil with viscosity of 36 cSt at 50°C)

Maximum operating pressure	bar	250
Minimum pressure difference between A and B		12
Maximum controlled flow rates	l/min	1 - 4 - 10 - 16 - 22
Minimum controlled flow rate (for 1 and 4 l/min)		0,035
Ambient temperature range	°C	-20 / +60
Fluid temperature range	°C	-20 / +80
Fluid viscosity range	cSt	10 ÷ 400
Fluid contamination degree	According to ISO 4406:1999 class 20/18/15	
Fluid contamination degree for flows < 0,5 l/min	According to ISO 4406:1999 class 18/16/13	
Recommended viscosity	cSt	25
Mass	kg	1,5
Number of adjustment knob turns	RPC1-*/T3	3
	RPC1-*/T3/M	1

HYDRAULIC SYMBOL

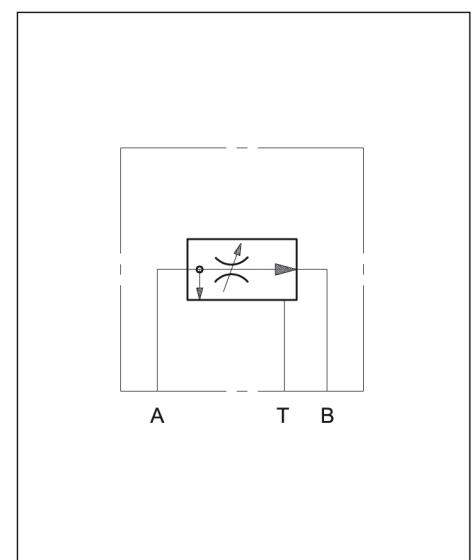

1 - IDENTIFICATION CODE

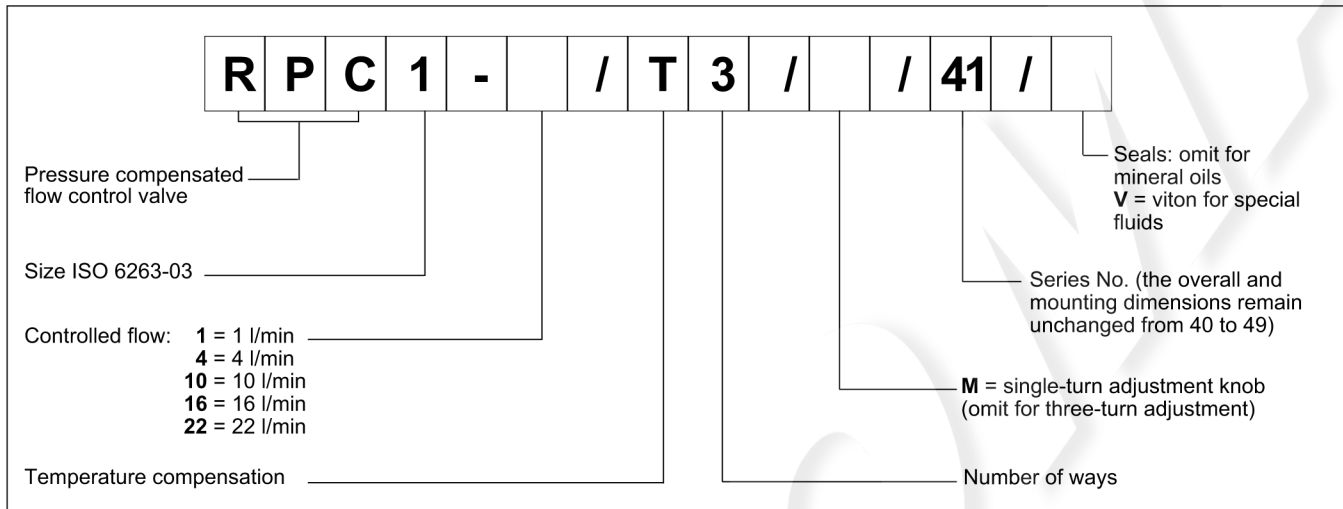

2 - CHARACTERISTIC CURVES (values obtained with viscosity of 36 cSt at 50°C)

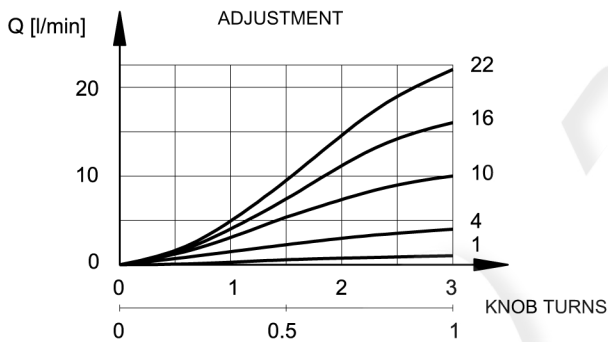

3 - HYDRAULIC FLUIDS

Use mineral oil-based hydraulic fluids HL or HM type, according to ISO 6743-4. For these fluids, use NBR seals. For fluids HFDR type (phosphate esters) use FPM seals (code V). For the use of other kinds of fluid such as HFA, HFB, HFC, please consult our technical department. Using fluids at temperatures higher than 80 °C causes a faster degradation of the fluid and of the seals characteristics.

The fluid must be preserved in its physical and chemical characteristics.

4 - PRESSURE COMPENSATION

Two throttles in series are in the valve. The first is an opening regulated by the knob; the second, piloted by the pressure upstream and downstream of the first throttle, assures a constant pressure drop across the adjustable throttle. In these conditions, the set flow rate value stays constant within a tolerance range of $\pm 2\%$ of the maximum flow controlled by the valve for maximum pressure variation between the intake and outlet chambers of the valve.

5 - TEMPERATURE COMPENSATION

The valve temperature compensation is obtained with the principle of fluid passage across a thin wall orifice in which the flow rate is not substantially influenced by the oil viscosity fluctuations. For controlled flows of less than 0,5 l/min and with a temperature difference of 50 °C, flow is increased by about 13% of the set flow value. For higher flow rates, and with the same temperature difference, the flow increase is about 4% of the maximum flow controlled by the valve.

6 - OVERALL AND MOUNTING DIMENSIONS

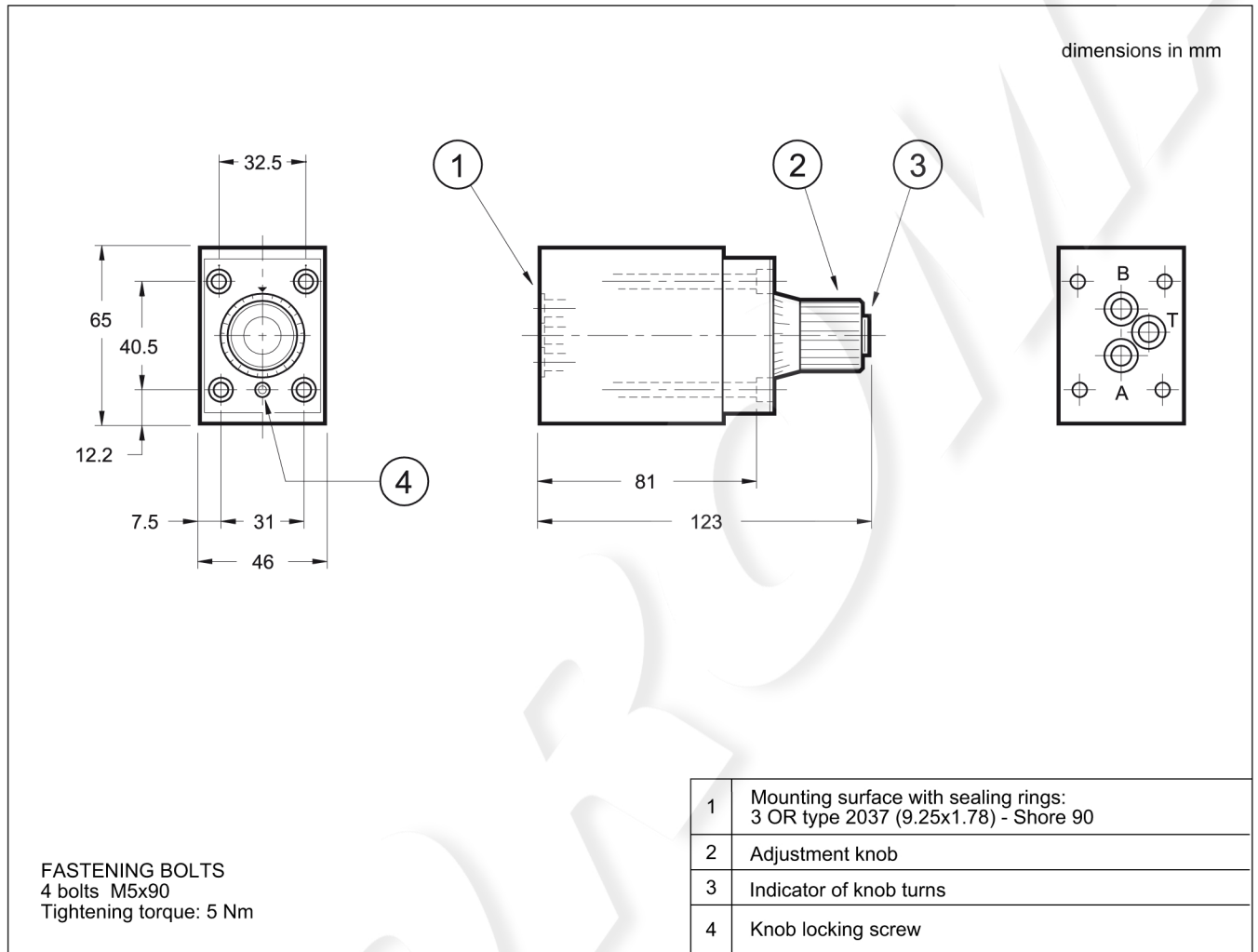

7 - APPLICATION EXAMPLE

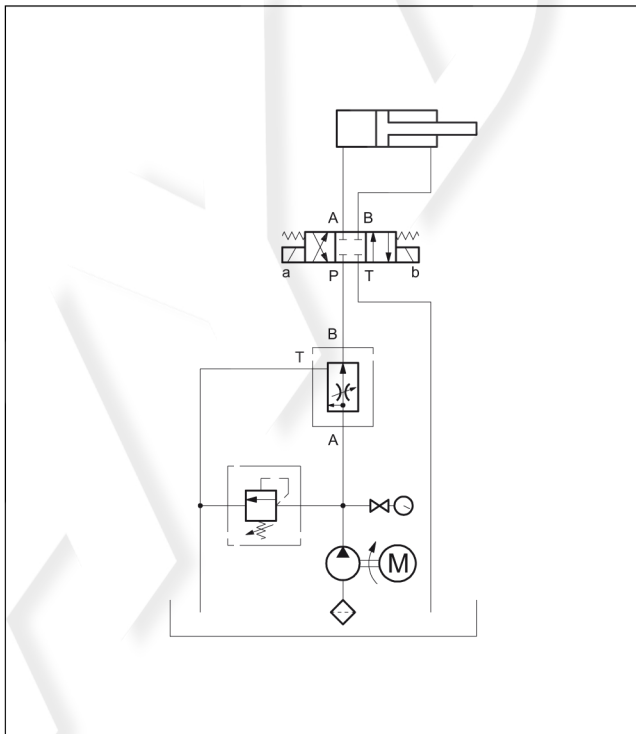

8 - SUBPLATES (see catalogue 51 000)

Type	PMMD-AI3G with rear ports with user P plugged
Type	PMMD-AL3G with side ports with user P plugged
Port dimension	3/8" BSP